

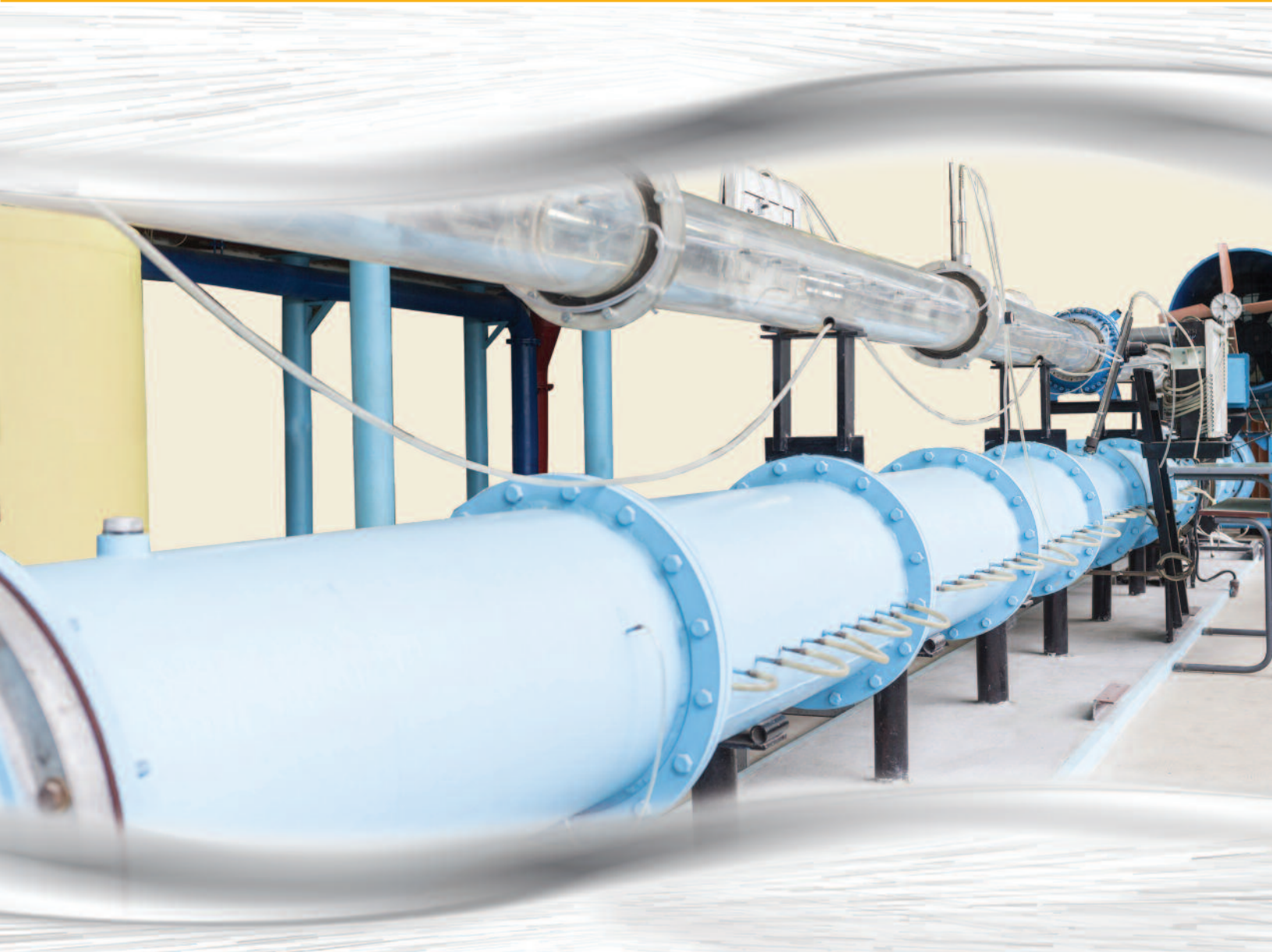

**CFM**<sup>™</sup>  
CONTINENTAL FAN

*better AIRFLOW by DESIGN*<sup>™</sup>

# ***IRIS Damper Application Guide***



# IRIS & IRIS-S DAMPERS

## INTRODUCTION

The IRIS damper is a brilliantly simple solution for fast and exact measurement, balance and control of airflow. It is ideal for supply and exhaust tracking control, individual comfort control, and any space requiring accurate airflow regulation. Applications for the IRIS damper include office buildings, pharmaceuticals, clean room environments and laboratories. Its unique design allows for airflow to be measured and controlled at a single station, thus saving time and money in initial installation and commissioning, and those applications requiring air balance on a regular basis.

## CONSTRUCTION

The IRIS damper is comprised of a casing, damper blades, an adjustment or regulating nut, an airflow adjustment chart, and airflow taps. Blades and casing are manufactured from either galvanized (IRIS) or 316 stainless steel (IRIS-S). The remaining components are made from high strength plastics and rubber.

## IRIS DAMPER FEATURES & BENEFITS

- Precise airflow measurement
- Accurate air balancing to +/- 5% in a straight duct
- Single station measurement and control
- Reduced field labor time
- Ideal for office buildings, pharmaceuticals, clean room environments and laboratories
- Compact design, superior performance
- Fully retractable blades for duct cleaning
- Available in an assortment of sizes for a broad range of airflow measurement requirements

## POSITIVE SEAL CONSTRUCTION (OPTIONAL)

Some applications may require a fully closed damper. For those requiring a 100% shutoff, a positive seal option is available on sizes 4" through 12", in both galvanized and stainless steel IRIS dampers.

## RECOMMENDED INSTALLATIONS

The calibration accuracy of an IRIS damper during disturbance free airflow is 5%. However, when an IRIS damper is installed near duct fittings, measurement accuracy may be affected. For optimum operation and airflow control, the chart (Fig. 1) indicates the recommended distances between an IRIS damper and duct elbows, tees and transitions. From the chart, to achieve the airflow accuracy,  $m_2$ , distance  $L_{min}$  defines the minimum distance separating an IRIS damper from the fitting.

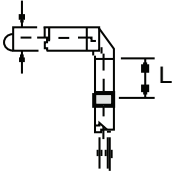
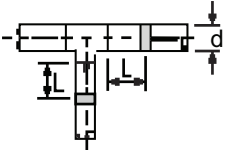
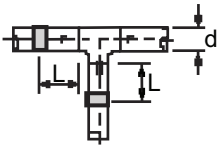
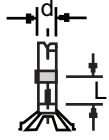
Fig. 1	$L_{min}$	
	$m_2 = \pm 7\%$	$m_2 = \pm 10\%$
	$\geq 1d$	$\geq 1d$
	$\geq 4d$	$\geq 2d$
	$\geq 2d$	$\geq 2d$
	$\geq 2d$	$\geq 2d$

## IRIS DAMPER

- Single station measurement and control
- Hot dipped galvanized steel construction
- Fitted EPDM gasket for airtight mounting
- Capacities: 15 cfm to 20,000 cfm
- Max operating temperature:
  - 180 F continuous
  - 250 F intermittent



## IRIS-S STAINLESS STEEL DAMPER

- AISI 316 stainless steel construction
- Prolonged excellence in extreme conditions
- Ideal for corrosive environments
- Capacities: 15 cfm to 20,000 cfm
- Max operating temperature:
  - 180 F continuous
  - 250 F intermittent

## IRIS & IRIS-S DIMENSIONS

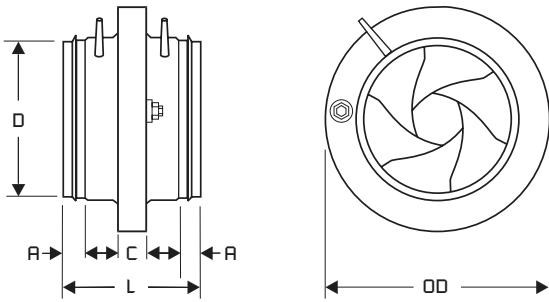

MODEL	DIMENSIONS IN INCHES					
	A	C	D	L	OD	WT(lbs)
IRIS-04, IRIS-S-04	1.2	0.6	3.9	4.6	6.5	1.1
IRIS-05, IRIS-S-05	1.2	0.6	4.9	4.6	7.4	1.5
IRIS-06, IRIS-S-06	1.2	0.6	5.9	4.6	9.1	2.0
IRIS-08, IRIS-S-08	1.2	0.6	7.8	4.6	11.2	3.1
IRIS-10, IRIS-S-10	1.6	0.7	9.8	5.3	13.2	4.6
IRIS-12, IRIS-S-12	1.6	0.7	11.8	6.1	16.1	7.7
IRIS-16, IRIS-S-16	2.4	0.8	15.7	7.5	20.7	14.1
IRIS-20, IRIS-S-20	2.0	0.8	19.6	6.7	25.8	21.2
IRIS-25, IRIS-S-25	2.0	0.9	24.7	6.7	32.1	34.4
IRIS-32, IRIS-S-32	3.9	0.9	31.4	10.6	40.0	55.1

## IRIS DAMPER SPECIFICATION GUIDE

### 1.0 GENERAL

- A. Iris dampers shall be model IRIS, as manufactured by Continental Fan Manufacturing Inc. and of the size and capacity as indicated on the drawings and damper schedule.

### 2.0 DAMPER CONSTRUCTION

- A. Iris dampers shall be manufactured of hot dipped galvanized 22 gage steel.
- B. Duct connections shall be gasketed and beaded to provide for a sealed duct connection.
- C. Airflow measurement taps shall be provided with airflow adjustment charts located on the damper for convenient airflow measurement and control. Damper shall be capable of controlling airflow to +/- 5% of design flow in a straight duct.
- D. Damper position shall be set with the factory supplied spanner wrench, with no zero calibration required. Dampers requiring zero calibration are not acceptable.
- E. Casing leakage to the environment shall not exceed 6 cfm.

## IRIS-S STAINLESS STEEL DAMPER SPECIFICATION GUIDE

### 1.0 GENERAL

- A. Iris dampers shall be model IRIS-S, as manufactured by Continental Fan Manufacturing Inc. and of the size and capacity as indicated on the drawings and damper schedule.

### 2.0 DAMPER CONSTRUCTION

- A. Iris dampers shall be manufactured of 316 acid proof stainless steel.
- B. Duct connections shall be gasketed and beaded to provide for a sealed duct connection.
- C. Airflow measurement taps shall be provided with airflow adjustment charts located on the damper for convenient airflow measurement and control. Damper shall be capable of controlling airflow to +/- 5% of design flow in a straight duct.
- D. Damper position shall be set with the factory supplied spanner wrench, with no zero calibration required. Dampers requiring zero calibration are not acceptable.
- E. Casing leakage to the environment shall not exceed 6 cfm.

## MATERIAL SPECIFICATIONS

Product Components	Material
Casing, blades	Galvanized steel or acid-proof steel (AISI 316)
Regulation mechanism	Polyacetal
Stickers, window cover	PVC plastic
Veloduct-sealing	EPDM rubber
Measuring tap	TPE rubber

## ORDERING SPECIFICATIONS

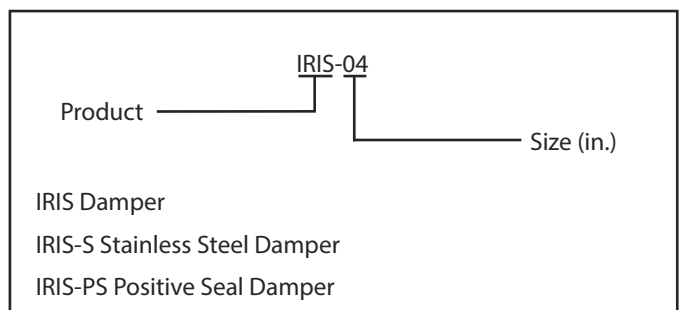

# IRIS DAMPER SELECTION CURVES

## SELECTION

The criteria to be considered when applying an IRIS damper are airflow, pressure drop and sound requirements. The IRIS damper represents a resistance to airflow in a duct, as do the duct and fittings.

Selecting an IRIS damper is simple. In the case of an existing duct, choose an IRIS damper to match duct size.

Alternatively, use the IRIS Damper Selection Curves on pages 4 and 5. Select an IRIS damper at a mid-range setting to match desired airflow and pressure drop. This establishes the required duct size. Additionally, this provides the end user with balancing flexibility in the event that airflow requirements should change.

Consideration of the total pressure drop and sound requirements at design airflow is important. The Selection Curves indicate the total pressure drop of an IRIS damper at a given airflow and damper position.

Additionally, sound pressure curves across various damper settings are provided.  $L_A$  is the sound pressure level with 4 dB room attenuation.

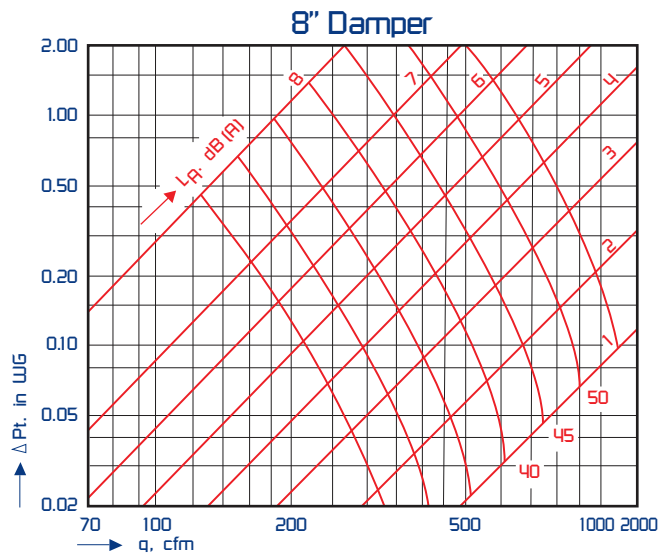
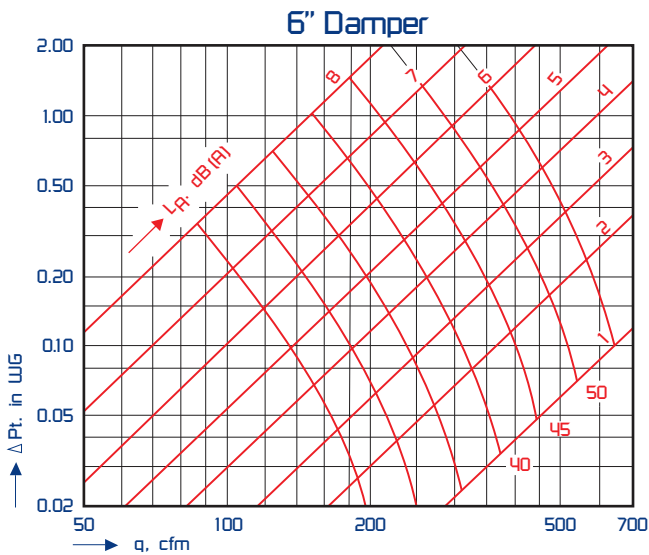
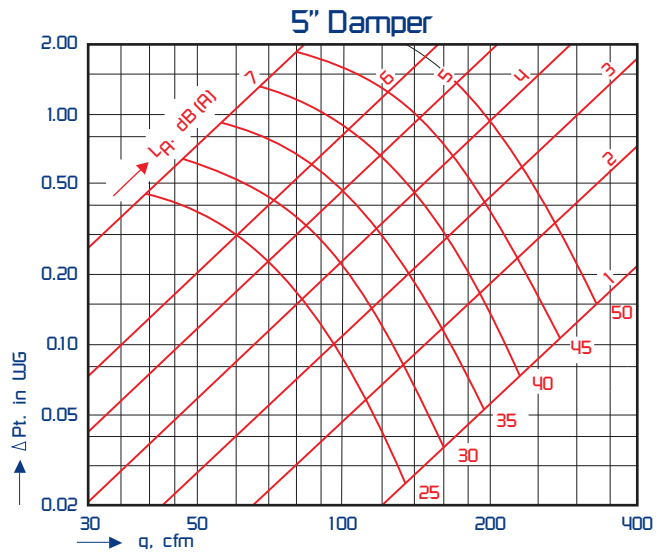
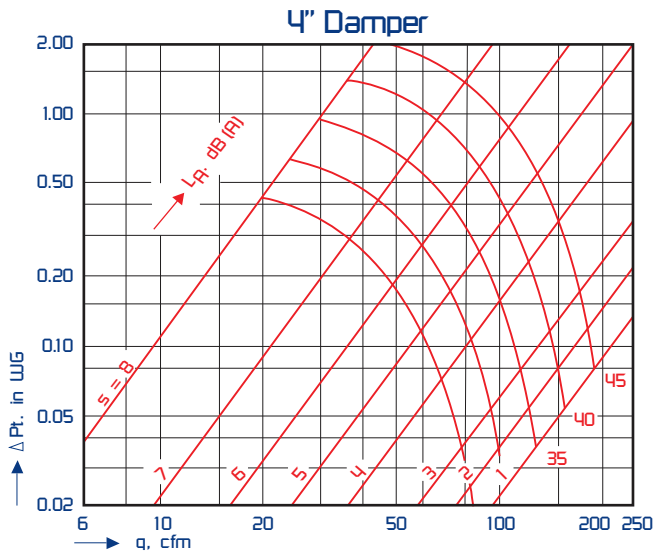



# IRIS DAMPER SELECTION CURVES

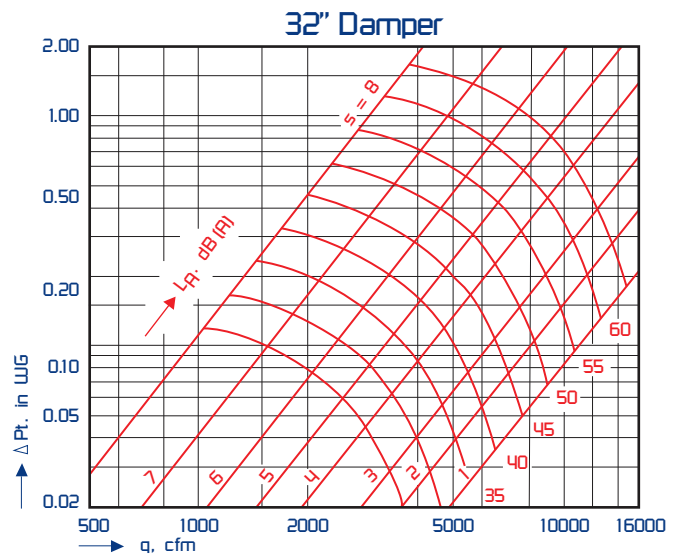
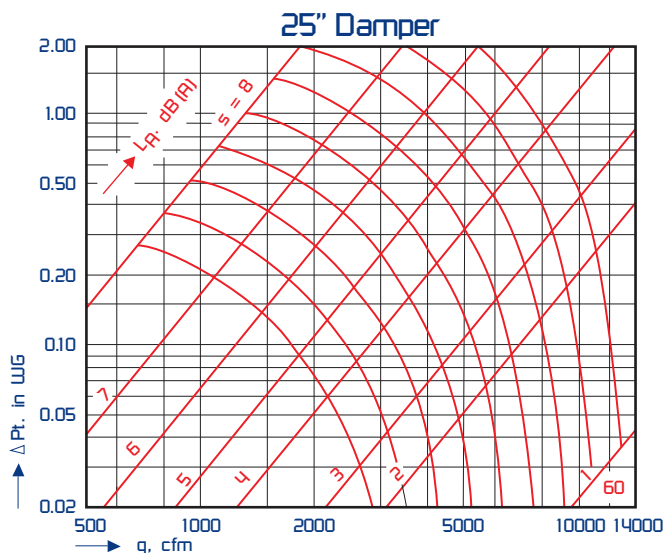
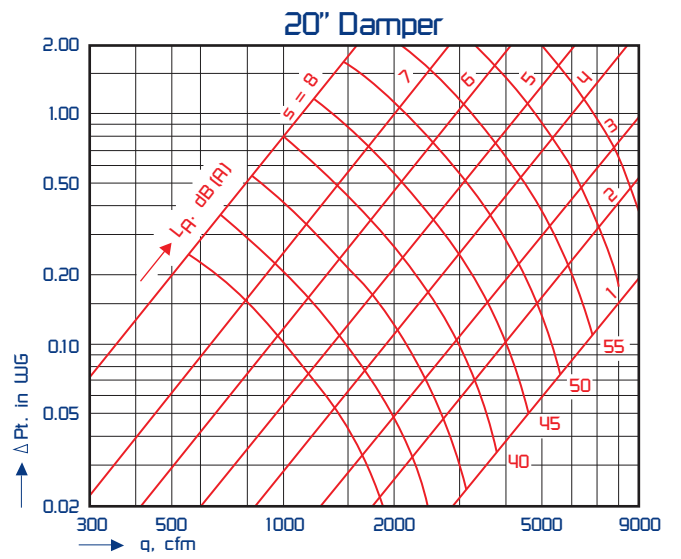
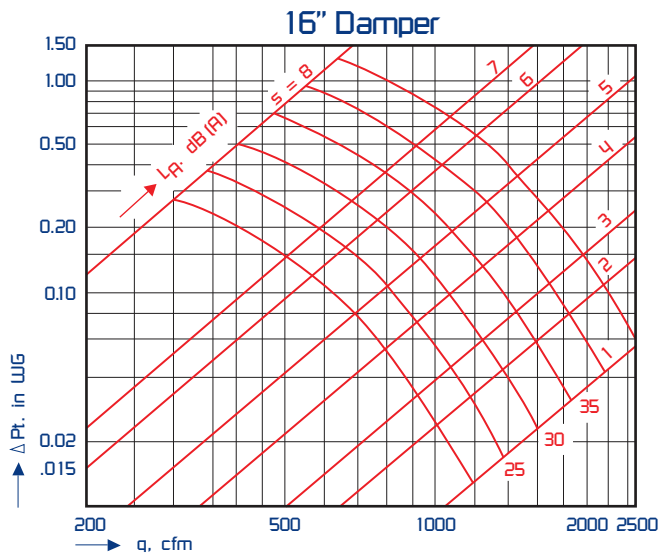
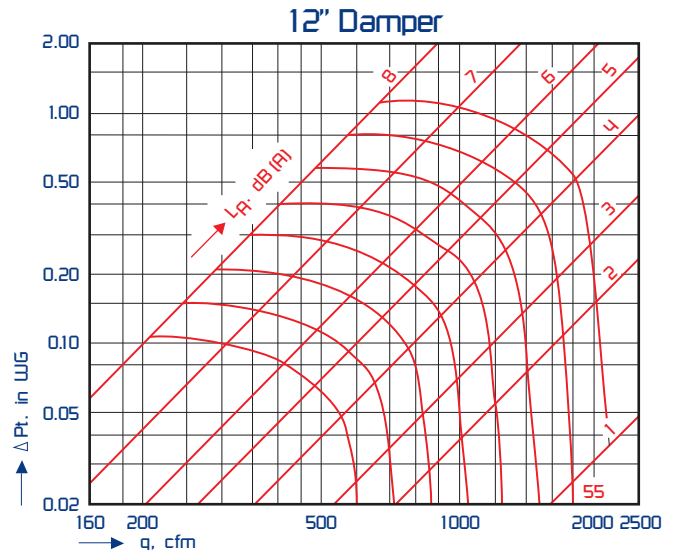
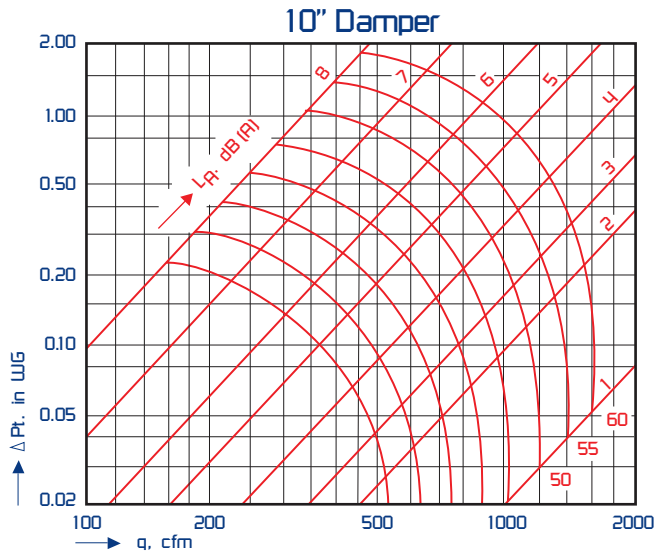

# AIRFLOW ADJUSTMENT CHARTS

## AIRFLOW CONTROL AND BALANCE

Once an IRIS damper has been installed and the system is operational, the damper may be adjusted to deliver required airflow using the airflow adjustment chart located on the damper. Airflow Adjustment Charts for IRIS and IRIS-S dampers are shown on pages 6 and 7.

Each IRIS damper contains two airflow taps (pressure ports) and an Airflow Adjustment Chart. By connecting a pressure gauge to the taps of the damper, the pressure drop across the damper blades can be measured. The illustration (Fig. 2) shows the setup for making a pressure measurement.

Each damper setting has a unique 'k' factor that defines the curves at different damper settings. The air velocity flowing through the orifice of the damper is proportional to the measured pressure drop. Once the velocity is known, the airflow can be easily calculated when the cross-sectional area of the orifice is known. The relationship between pressure drop and airflow through an IRIS damper is:

$$q = k \sqrt{\Delta p_m}$$

q = airflow (cfm)

$\Delta p_m$  = measured pressure drop (in. w.g.)

k = constant of proportionality  
(dependent upon orifice area)

For initial airflow balance, note the damper position and related pressure drop. Refer to the Airflow Adjustment Charts to determine the airflow.

To adjust to a new airflow, locate the desired airflow on the Airflow Adjustment Chart and adjust the damper position until the required pressure drop is achieved (Fig. 3).

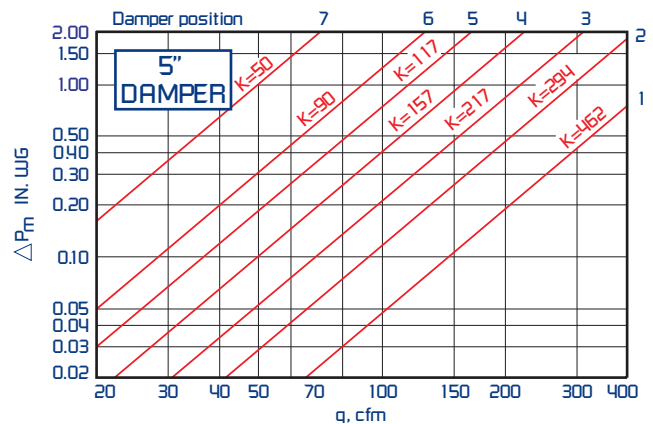
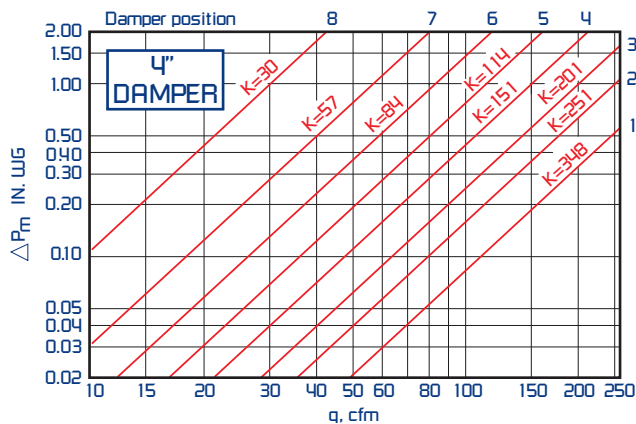
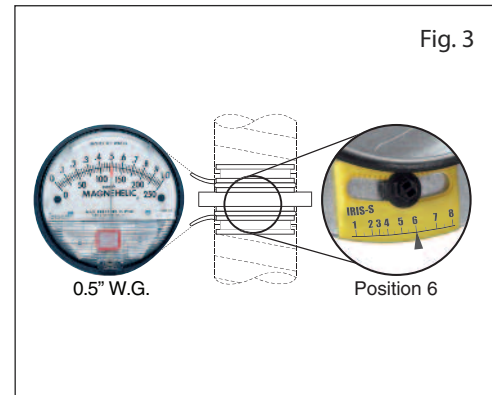
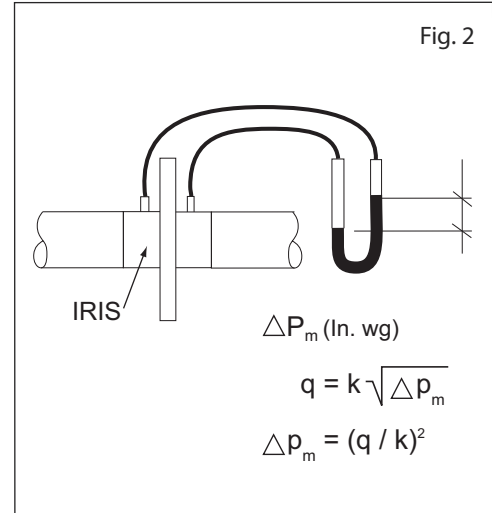

# AIRFLOW ADJUSTMENT CHARTS

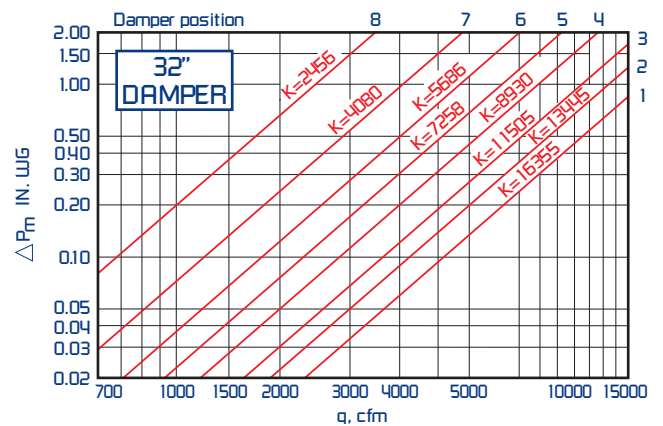
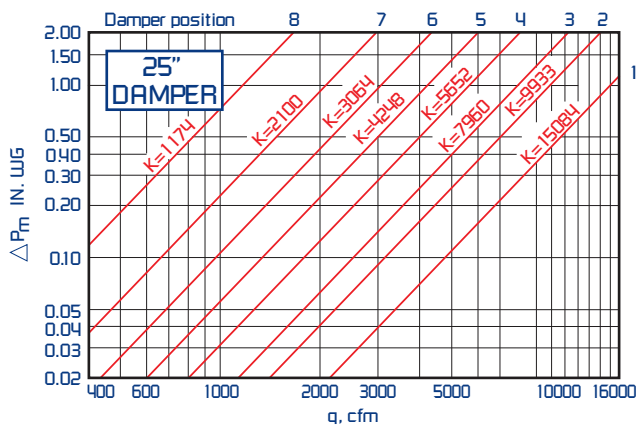
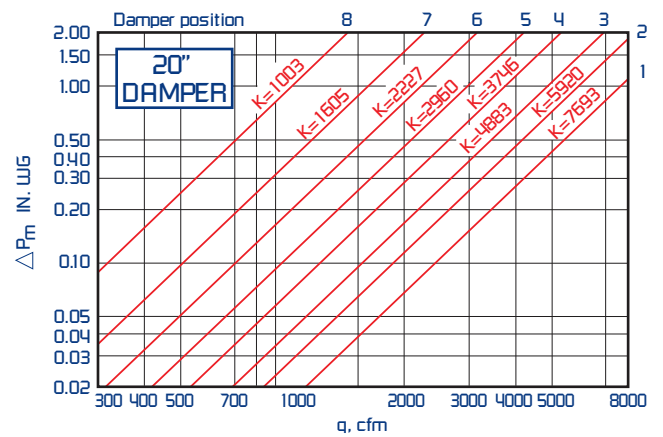
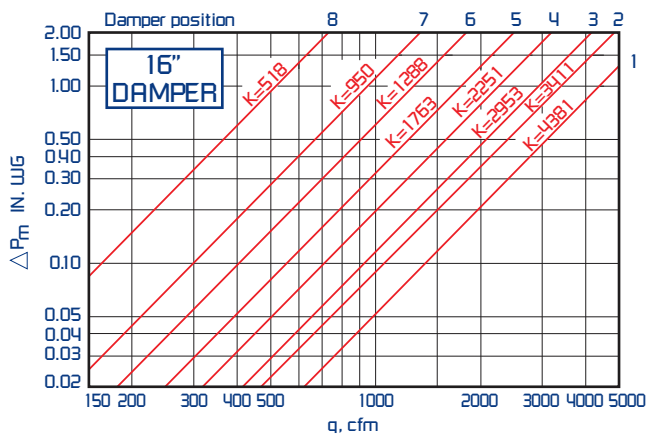
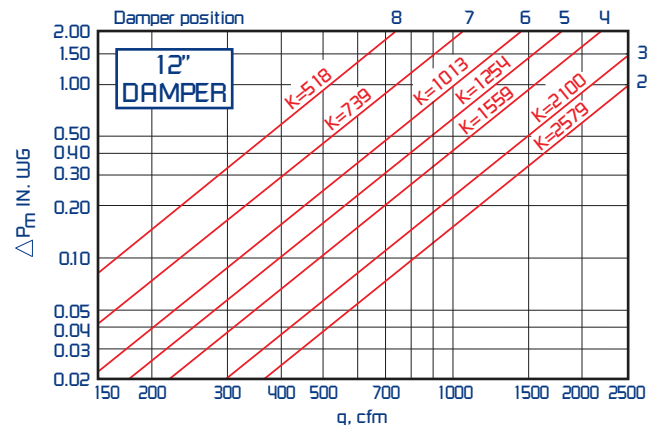
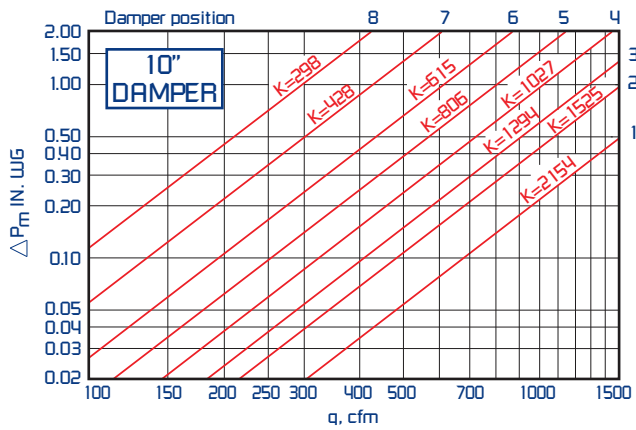
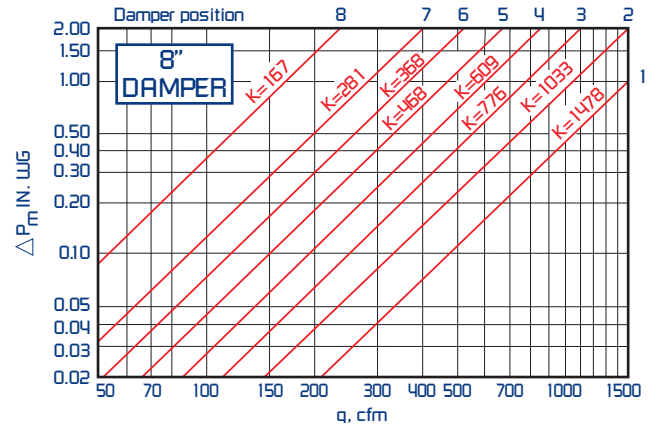
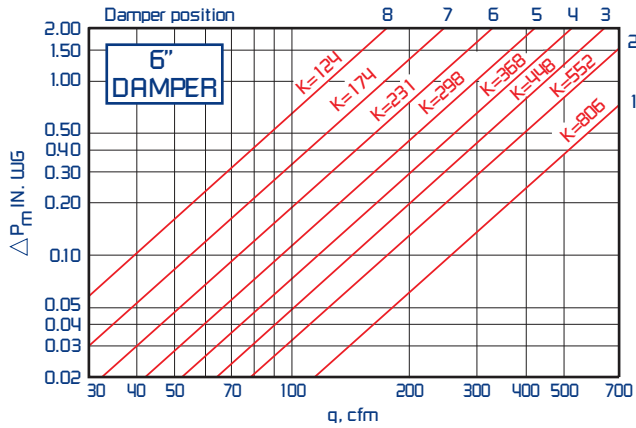

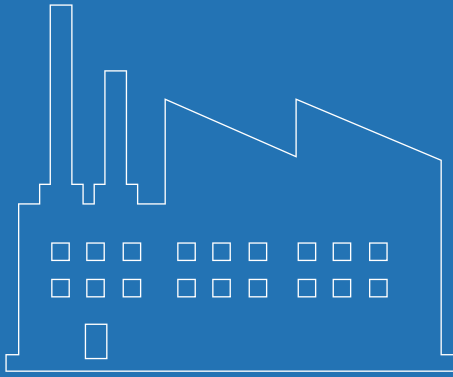

***Industrial Fans  
& Blowers***

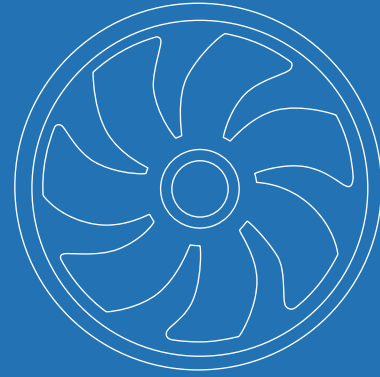

***OEM Solutions  
& Custom Fans***



***Commercial Fans  
& Dampers***



***Residential Fans &  
Air Purifiers***



# Iris Damper Application Guide

Continental Fan Manufacturing Inc.  
203 Eggert Road  
Buffalo, New York 14215

Continental Fan Canada Inc.  
12-205 Matheson Blvd. E  
Mississauga, Ontario L4Z 3E3

Continental Fan Manufacturing Inc.  
6274 Executive Blvd.  
Dayton, Ohio 45424

1-800-779-4021 • [www.continentalfan.com](http://www.continentalfan.com)

Distributed by:

IRIS-AP-1804