

CFMTM
CONTINENTAL FAN

Wholesale Ventilation Products

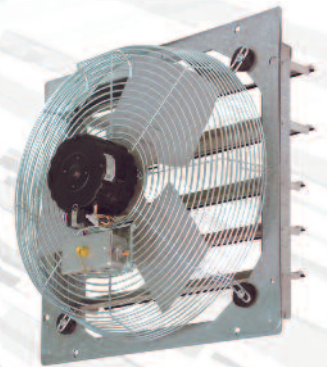
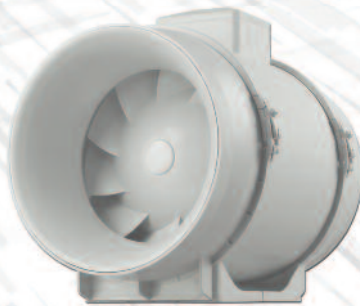
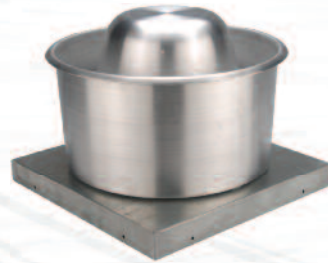

... better AIRFLOW by DESIGN!

AIR PURIFIERS

CX AIR PURIFIERS

CX Air Purifiers are the most advanced in the world, dealing with all facets of air purification:

Particle Removal Chemical Neutralization Living Organism Abatement

Using patented technology, CX Air Purifiers remove airborne particles, neutralize odors and chemicals, and render germs, viruses and bacteria harmless.

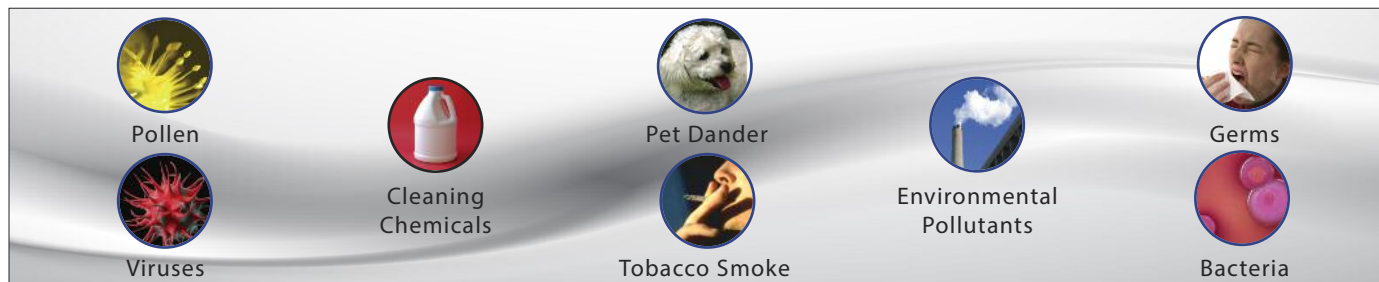

CX Air Purifiers:

- Create a cleaner environment
- Alleviate fatigue & headaches
- Reduce asthma, hay fever & sinus problems
- Cut dust & cleaning requirements
- Promote health & wellness
- Ease breathing problems
- Control pet odors & dander
- Relieve sore throats, runny noses & sneezing

Photo-Catalytic Oxidation

CX Air Purifiers incorporate patented Photo-Catalytic Oxidation technology, using UVC light to activate a highly reactive catalyst. This process converts harmful and toxic compounds into benign constituents, such as water and carbon dioxide.

Easy Maintenance

CX Air Purifiers are designed for easy maintenance to ensure peak performance at all times. Built-in electronic service lights indicate when filters and UVC lamps require replacement.

Electronic Sensor

CX1000 Portable Air Purifiers feature an electronic sensor that constantly monitors air quality. Airflow automatically increases to compensate for periods of unusually high chemical activity or particle count. Warning lights signal the presence of toxic chemicals and fumes well before they reach dangerous levels or become detectable to the human senses.

MODEL	CX1000 Portable Air Purifier	CX3000GS Ducted Air Purifier
DIMENSIONS	21.3" w x 19.0" h x 8.0" d	25.5" w x 21.0" h x 10.0" d
WEIGHT	23 lbs.	26 lbs.
MAXIMUM AIRFLOW	265 cfm	2,170 cfm
POWER CONSUMPTION	110 watts	45 watts
VOLTAGE	1/120V/60	1/120V/60
BLOWER	Backward-curved motorized impeller	N/A
UVC LAMP(S)	10 watts	(2) 22 watts per bulb (44 watts total)
MICROWATTS AT SURFACE PER CM ²	16,000	21,000
MICROWATTS @ 1'	540	1,125
UV RANGE	254 NM (germicidal)	254 NM (germicidal)
FILTERS	5 micron pre-filter; 0.3 micron hospital grade HEPA filter	Electrostatic needled fiber MERV-11
1ST STAGE GAS TREATMENT LAYER	Activated carbon	N/A
2ND STAGE GAS TREATMENT LAYER	Activated carbon	N/A
APPLICATION	1,000 sq. ft. (automode)	3,000 sq. ft.
SERVICE INTERVAL*	UVC lamp 1 year, filters 2 years	UVC lamp 1 year, filters 6 months
CATALYST	Metal Oxides	Metal Oxides
WARRANTY	2 years excluding lamp and filters	2 years excluding lamps and filters

*SERVICE INTERVALS ARE SUBJECTIVE TIMES AND MAY FLUCTUATE BASED ON ENVIRONMENT.

CX1000 PORTABLE AIR PURIFIER

The CX1000 Portable Air Purifier is designed to remove airborne particles, neutralize chemicals, and abate living organisms.

CX1000 Portable Air Purifier uses a five-stage process to purify indoor air:

1. Treated Pre-Filter - Removes Particles to 5 Microns
2. Activated Carbon Filters (2) - Reduce Toxic Chemicals and Gases
3. Hospital Grade HEPA Filter - Purges Allergens to 0.3 Microns
4. Reactive Catalyst - Neutralizes VOC's, Toxic Chemicals, and Odors
5. UVC Light - Renders Germs, Viruses, and Bacteria Harmless



CX1000 PORTABLE AIR PURIFIER

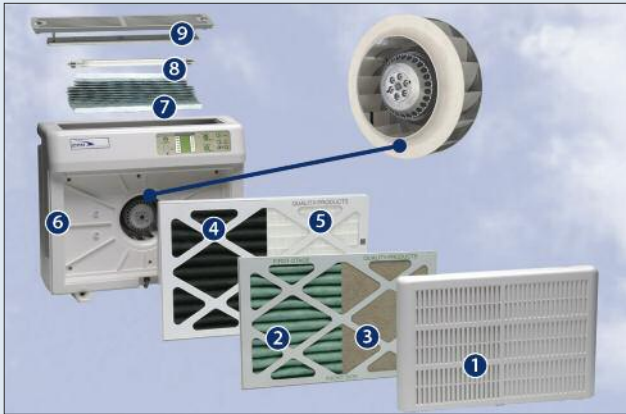

1. Air inlet grille with safety lock
2. Pre-filter
3. 1st stage gas adsorption layer
4. 2nd stage gas adsorption layer
5. Hospital grade HEPA filter
6. High impact ABS plastic
7. Photo-catalytic converter
8. High output germicidal UVC lamp
9. Air outlet grille with safety lock

CX3000GS DUCTED AIR PURIFIER

The CX3000GS Ducted Air Purifier is rated for use at standard ambient air temperatures and designed to operate with any heating or air-conditioning system, up to five tons in size.

CX3000GS Ducted Air Purifier uses a four-stage process to purify indoor air:

1. Electrostatic MERV-11 Filter - Removes Allergens to 0.3 Microns
2. Reactive Catalyst - Neutralizes VOC's, Toxic Chemicals, and Odors
3. UVC Light - Renders Germs, Viruses, and Bacteria Harmless
4. Negative Ions and Activated Oxygen - Keep Air Fresh and Clean



CX3000GS DUCTED AIR PURIFIER



1. Electrostatically charged needled fiber MERV-11 filter
2. Powder coated Paint-Loc steel case
3. High output germicidal UVC lamps
4. Rust-proof gold zinc plated pull out case
5. Cabinet locks
6. Quick disconnect power cord
7. Photo-catalytic converter - 70 sq. ft. of surface area
8. Sight ports to verify lamp operation
9. Computerized service panel

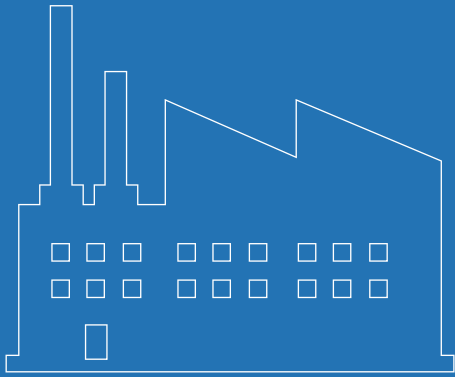

***Industrial Fans
& Blowers***

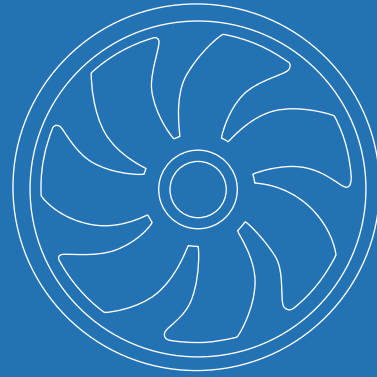

***OEM Solutions
& Custom Fans***



***Commercial Fans
& Dampers***



***Residential Fans &
Air Purifiers***



Wholesale Ventilation Products

Continental Fan Manufacturing Inc.
203 Eggert Road
Buffalo, New York 14215

Continental Fan Canada Inc.
12-205 Matheson Blvd. E
Mississauga, Ontario L4Z 3E3

Continental Fan Manufacturing Inc.
6274 Executive Blvd.
Dayton, Ohio 45424

1-800-779-4021 • www.continentalfan.com

Distributed by:

