

CFMTM
CONTINENTAL FAN

Wholesale Ventilation Products

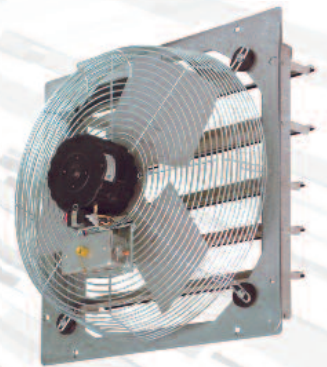
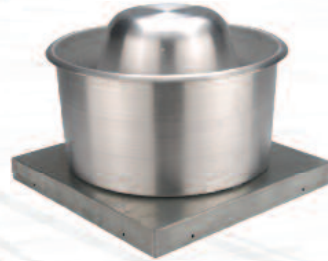

... better AIRFLOW by DESIGN!

ENERGY RECOVERY VENTILATORS

ECO-FLO ENERGY RECOVERY VENTILATOR (ERV)

The ECO-FLO Energy Recovery Ventilator (ERV) is the all-in-one ventilation solution for new construction and renovation projects involving homes, apartments, offices, or commercial buildings. This compact unit is capable of exhausting stale air and supplying fresh filtered air. The ERV core extracts thermal energy and moisture from the exhausted air, and uses it to pre-treat the incoming supply air.

FEATURES & BENEFITS

- Extracts stale indoor air
- Recovers thermal energy from extracted air
- Supplies fresh, pre-treated air
- Maintains a comfortable humidity setting
- Moisture damage prevention
- Lowers heating and cooling costs throughout the year
- Low energy demand (5.61 W)
- Quiet operation (as low as 0.2 SONES)
- Multifunctional wireless remote control
- Plug-&-Play installation
- Air purification (MERV 6)
- Rated for continuous operation



CONSTRUCTION

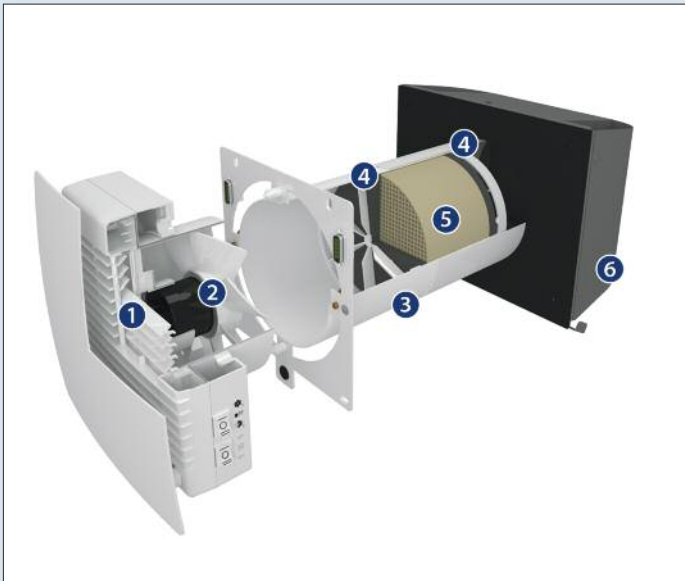

1. Front Grille with Automatic Shutter
 - Easy access for filter cleaning or replacement
 - Made of high quality snow-white ABS plastic
2. Reversible Axial Fan
 - Efficient EC ball bearing motor (5.7 cfm/W)
 - Integrated overheating protection
3. Telescopic Duct
 - 6" diameter
 - Suitable for walls of varying thickness
4. Air Filters (MERV 6)
 - Two filters provide air free of dust & pollen
 - Filters are washable for easy maintenance
5. ERV Core
 - Recovery efficiency of 90% @ 32 F
 - Anti-bacterial treatment
6. Exterior-Mounted Hood
 - Stainless steel
 - Corrosion proof

APPLICATIONS

	One ECO-FLO Unit	Synchronous Pair	Multiple Units
Maximum Ventilation	343 square feet	686 square feet	Entire home or commercial building



ENERGY RECOVERY VENTILATORS

OPERATION MODES

Natural Airflow

-  Shutter is open; fan does not run.
- Air flows freely through ventilator and is purified by filters.

Supply Mode

-  Ventilator continuously draws in fresh air from outside.
- Air is purified by the filters.

Ventilation Mode

-  Ventilator operates in permanent supply or extract mode.
- Synchronized units can provide balanced ventilation.

Regeneration Mode

-  Ventilator alternates between supply and exhaust every 70 seconds.
- Thermal energy is recovered, and the humidity setting is maintained.

Cycle I

Warm stale air is extracted from the room. It heats and moisturizes the ERV core, transferring up to 90% of thermal energy. In 70 seconds, the ventilator switches to supply mode.

Cycle II

Fresh outside air flows through the ventilator, absorbing the accumulated moisture and thermal energy in the ERV core and supplying warmed air into the room. In 70 seconds, the ventilator switches back to extraction mode.

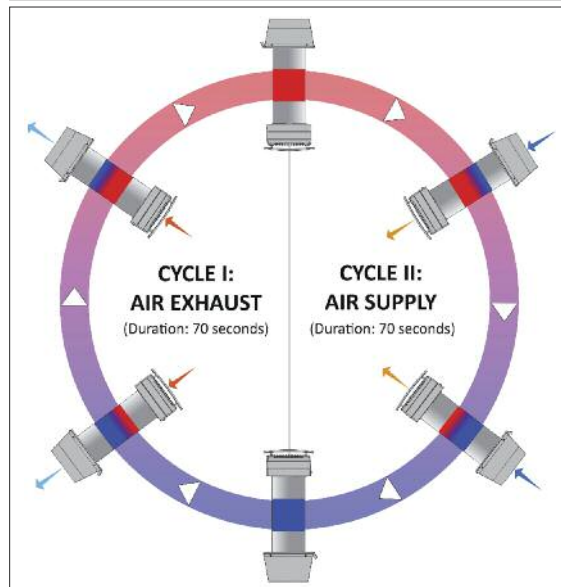
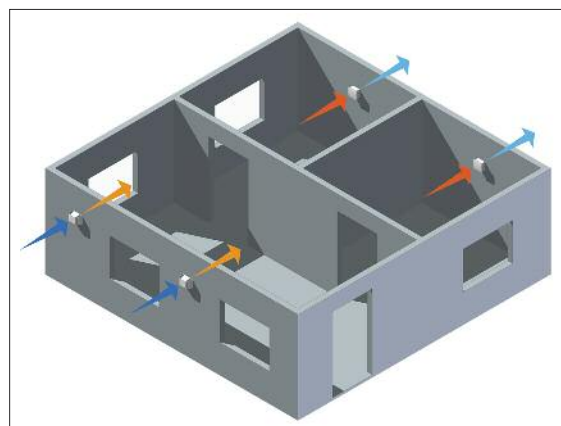

SPECIFICATIONS

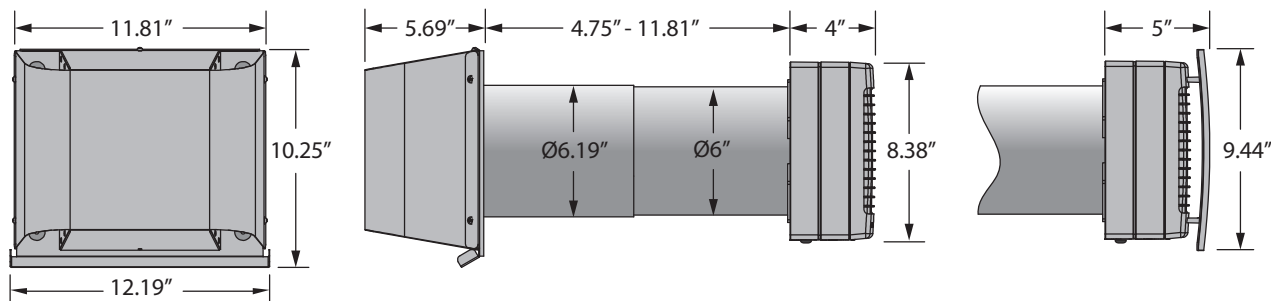

MODEL	MANUFACTURE CODE	THERMAL RECOVERY	PERFORMANCE						TRANSPORTED AIR TEMP. (F)	POWER SUPPLY
			SPEED	RPM	SONES @ 3M	WATTS	AMPS	CFM		
ECO-FLO	RA1-50-2	90%	Low	610	0.2	3.80	0.024	8	From -4 up to 122	120 V 60 Hz 1 Phase
			Med	800	0.4	3.96	0.026	16		
			High	1450	0.5	5.61	0.039	32		

IP24 protection

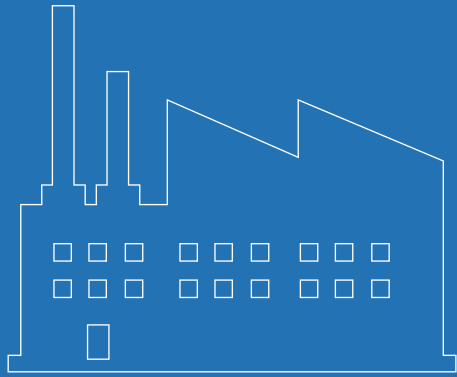

***Industrial Fans
& Blowers***

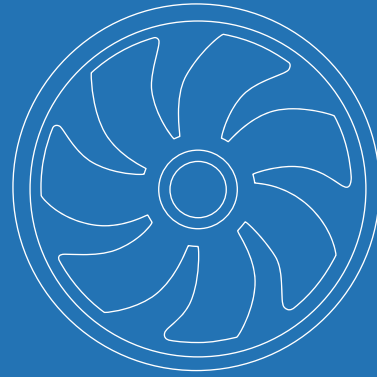

***OEM Solutions
& Custom Fans***



***Commercial Fans
& Dampers***



***Residential Fans &
Air Purifiers***



Wholesale Ventilation Products

Continental Fan Manufacturing Inc.
Buffalo, New York

Continental Fan Canada Inc.
Mississauga, Ontario

Continental Fan Manufacturing Inc.
Dayton, Ohio

1-800-779-4021 • www.continentalfan.com

Distributed by:

